

SURFACE MOUNT
PERMANENT
(BDC3PS)

SURFACE MOUNT
REMOVABLE
(BDC3RS)

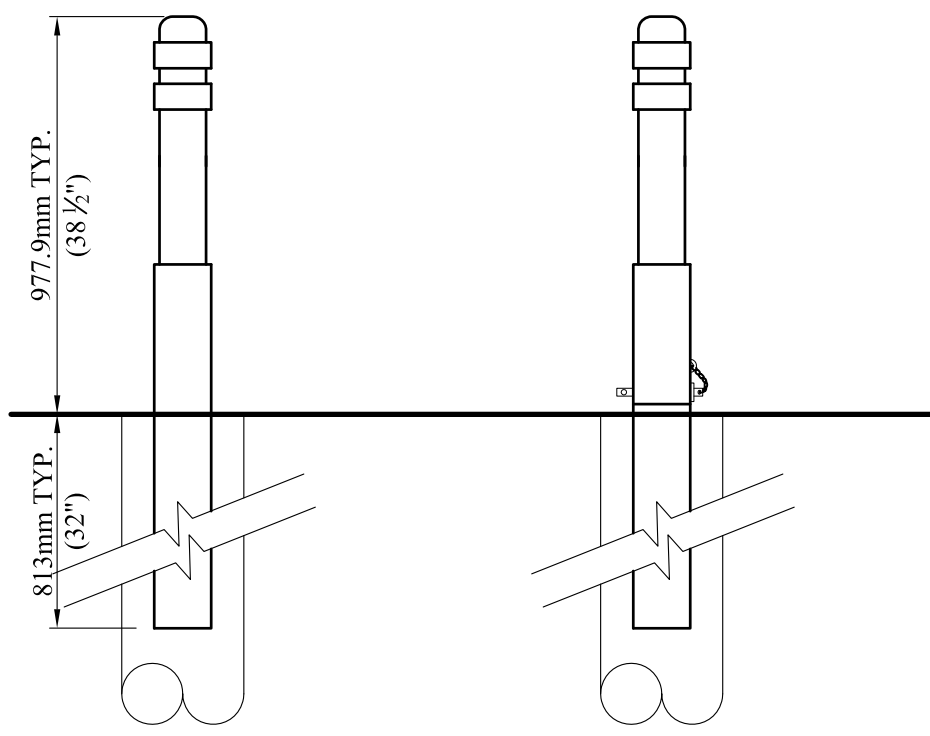

IN GROUND PERMANENT
(BDC3PG)

IN GROUND REMOVABLE
(BDC3RG)

DECORATIVE BOLLARD C-3

SPECIFICATIONS

STEEL:

- OUTER SLEEVE 140.0mm (5 1/2") O.D. SCHEDULE 40 PIPE
- INNER SLEEVE 114.3mm (4 1/2") O.D. SCHEDULE 40 PIPE

DOME TOP:

- 114.3mm (4 1/2") HOLLOW

BASE PLATE:

- 12.7mm (1/2") PLATE

STEEL FINISH:

- 3 STEP POWDER COAT PROCESS:

1. SURFACE PREPARATION- SANDBLAST METAL
2. PRIME COAT- APPLICATION OF ZINC RICH PRIMER
3. TOP COAT- FINAL COATING IS BAKED ON FOR THE BEST IN LONG LASTING DURABILITY

REMOVABLE BOLLARD OPTION AVAILABLE. SEE SPEC SERIES REMOVABLE BOLLARD FOR MORE INFO.

WELD ON QUICK LINK AVAILABLE FOR CHAIN ATTACHMENT. (CHAIN SOLD SEPARATELY).

AVAILABLE IN A WIDE VARIETY OF COLORS. REFER TO COLOR CHART FOR MORE INFORMATION.



4111-17th Street SE Calgary, AB T2G 3W5
 Ph# 569-8180 Fax# 272-4544
 e-mail: reception.cpl@telus.net
www.custompark.com